

EMC Test Report
For
Wenzhou Yijie Electric Co., Ltd
SOCKET

Model: MT2001, MT2016, MT2102, MT2116, LB2001, LB2102, LN2001, LN2016, LN2102, LN2116, LG2001, LG2102, EV2001, EV2016, EV2102, EV2116, AB2001, AB2102, AN2001, AN2016, AN2116, AN2102, AG2001, AG2102

Prepared For : Wenzhou Yijie Electric Co., Ltd
No. 83, Fengquan Road, Tianhe street, Wenzhou Economic and Technological Development Zone, Wenzhou City, Zhejiang Province

Prepared By : Beide (Shenzhen) Product Service Limited
China: 6F, Bldg E, Hourui 3rd Ind Zone, Xixiang, Bao'an Dist, Shenzhen, China

Report Number: B-E2206A1847
Date of Test: 2022-06-02 to 2022-06-08
Date of Report: 2022-06-09

TABLE OF CONTENT

Description	Page
Test Report Declaration	
1. TEST RESULTS SUMMARY	5
2. GENERAL INFORMATION	6
2.1. Report Information	6
2.2. Description of Device (EUT)	6
2.3. Test Facility	6
2.4. Test Uncertainty.....	6
2.5. Test Condition.....	7
2.6. Test Conditions	7
2.7. Performance Criterion	7
3. TEST INSTRUMENT USED.....	8
3.1. For Conducted Emission Test.....	8
3.2. For Radiation Emission Test	8
3.3. For Harmonic / Flicker Test	8
3.4. For Electrostatic Discharge Immunity Test	8
3.5. For Radio Frequency Electromagnetic Field	9
3.6. For Electrical Fast Transient/Burst Test.....	9
3.7. For Surge Test.....	9
3.8. For Injected Currents Susceptibility Test	9
3.9. For Voltage Dips and Interruptions Test	9
4. POWER LINE CONDUCTED EMISSION TEST.....	10
4.1. Block Diagram of Test Setup	10
4.2. Test Standard.....	10
4.3. Power Line Conducted Emission Limit	10
4.4. EUT Configuration on Test	10
4.5. Operating Condition of EUT	11
4.6. Test Procedure	11
4.7. Power Line Conducted Emission Test Results.....	11
5. RADIATION EMISSION TEST	12
5.1. Block Diagram of Test Setup	12
5.2. Test Standard	12
5.3. Radiation Emission Limit	12
5.4. EUT Configuration on Test	12
5.5. Operating Condition of EUT	13
5.6. Test Procedure	13
5.7. Radiation Emission Test Results	13
6. HARMONIC CURRENT EMISSION TEST	14
6.1. Block Diagram of Test Setup	14
6.2. Test Standard.....	14
6.3. Operating Condition of EUT	14
6.4. Test Results	14
7. VOLTAGE FLUCTUATIONS & FLICKER TEST	15
7.1. Block Diagram of Test Setup	15
7.2. Test Standard.....	15
7.3. Operating Condition of EUT	15
7.4. Test Results	15
8. ELECTROSTATIC DISCHARGE TEST.....	16
8.1. Block Diagram of Test Setup	16
8.2. Test Standard.....	16
8.3. Severity level and Performance criterion.....	17
8.4. EUT Configuration on Test	17

8.5. Operating Condition of EUT	17
8.6. Test Procedure	17
8.7. Test Results	17
9. RF FIELD STRENGTH SUSCEPTIBILITY TEST	19
9.1. Block Diagram of Test Setup	19
9.2. Test Standard	19
9.3. Severity level and Performance criterion	19
9.4. EUT Configuration on Test	19
9.5. Operating Condition of EUT	19
9.6. Test Procedure	20
9.7. Test Results	20
10. ELECTRICAL FAST TRANSIENT/BURST TEST	22
10.1. Block Diagram of Test Setup	22
10.2. Test Standard	22
10.3. Severity level and Performance criterion	22
10.4. EUT Configuration on Test	22
10.5. Operating Condition of EUT	23
10.6. Test Procedure	23
10.7. Test Results	23
11. SURGE TEST	25
11.1. Block Diagram of Test Setup	25
11.2. Test Standard	25
11.3. Severity level and Performance criterion	25
11.4. EUT Configuration on Test	25
11.5. Operating Condition of EUT	25
11.6. Test Procedure	26
11.7. Test Results	26
12. INJECTED CURRENTS SUSCEPTIBILITY TEST	28
12.1. Block Diagram of Test Setup	28
12.2. Test Standard	28
12.3. Severity Levels and Performance Criterion	28
12.4. EUT Configuration on Test	28
12.5. Operating Condition of EUT	28
12.6. Test Procedure	29
12.7. Test Results	29
13. VOLTAGE DIPS AND INTERRUPTIONS TEST	31
13.1. Block Diagram of Test Setup	31
13.2. Test Standard	31
13.3. Severity level and Performance criterion	31
13.4. EUT Configuration	31
13.5. Operating Condition of EUT	32
13.6. Test Procedure	32
13.7. Test Results	32

APPENDIX II (EUT PHOTOS)

(1 pages)

TEST REPORT DECLARATION

Applicant : Wenzhou Yijie Electric Co., Ltd
Address : No. 83, Fengquan Road, Tianhe street, Wenzhou Economic and Technological Development Zone, Wenzhou City, Zhejiang Province
Client ID : CA1706
Report Query : 
Manufacturer : Same As Holder
Trade Maek : **ETTROIT**
EUT Description : SOCKET
Model No. : See Page1
Remark : Use MT2001 do all the tests.
Rating Supply : 250V~,16A

Test Procedure Used:

EN 61000-6-3:2007+A1:2011; EN IEC 61000-3-2:2019+A1:2021;
EN 61000-3-3:2013+A1:2019;
EN IEC 61000-6-1:2019 (EN 61000-4-2:2009, EN 61000-4-3:2006+A2:2010,
EN 61000-4-4:2012, EN 61000-4-5:2014+A1:2017,
EN 61000-4-6:2014+AC:2015, EN 61000-4-11:2004+A1:2017)

The device described above is tested by Beide (Shenzhen) Product Service Limited to determine the maximum emission levels emanating from the device, the severe levels which the device can endure and EUT's performance criterion. The test results are contained in this test report. Beide (Shenzhen) Product Service Limited is assumed of full responsibility for the accuracy and completeness of these tests.

This report applies to above tested sample only and shall not be reproduced in part without written approval of Beide (Shenzhen) Product Service Limited.

Note: P=PASS, F=Fail, N/A= Not Applicable

Date of Test : 2022-06-02 to 2022-06-08

Prepared by : 
(Sophia jiang)

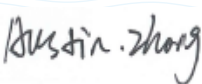
Checked by : 
(Austin zhong)

Approved by : 
(Martin wang)



1. TEST RESULTS SUMMARY

Test Results Summary

Test Items	Test Results
1 Conducted Disturbance Test	N/A
2 Radiation Emission Test	N/A
3 Harmonic Current Emission Test	N/A
4 Voltage Fluctuations & Flicker Test	N/A
5 Electrostatic Discharge Test	PASS
6 Radio Frequency Electromagnetic Field	N/A
7 Electrical Fast Transient/Burst Test	N/A
8 Surge Test	N/A
9 Injected Currents Susceptibility Test	N/A
10 Voltage Dips And Interruptions Test	N/A

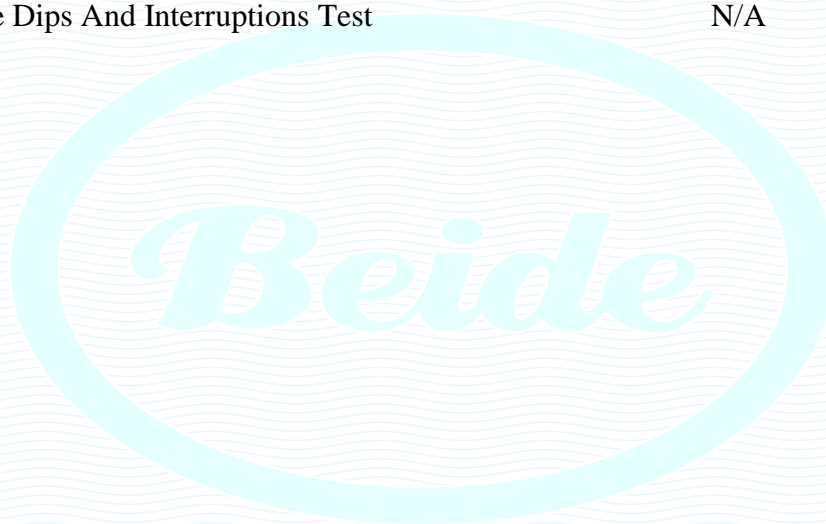

2.GENERAL INFORMATION

2.1.Report Information

2.1.1. This report is not a certificate of quality, it only applies to the sample of the specific product/equipment given at the time of its testing. The results are not used to indicate or imply that they are application to the similar items. In addition, such results must not be used to indicate or imply that BEIDE approves recommends or endorses the manufacture, supplier or use of such product/equipment, or that BEIDE in any way guarantees the later performance of the product/equipment.

2.1.2. The sample/s mentioned in this report is/are supplied by applicant, BEIDE therefore assumes no responsibility for the accuracy of information on the brand names, model number, origin of manufacture or any information supplied.

Additional copies of the report are available to the applicant at an additional fee. No third part can obtain a copy of this report through BEIDE, unless the applicant has authorized BEIDE in writing to do so.

2.2.Description of Device (EUT)

Description : SOCKET

Number Model : MT2001

Applicant : Wenzhou Yijie Electric Co., Ltd
No. 83, Fengquan Road, Tianhe street, Wenzhou Economic and Technological Development Zone, Wenzhou City, Zhejiang Province

Manufacturer : Wenzhou Yijie Electric Co., Ltd
No. 83, Fengquan Road, Tianhe street, Wenzhou Economic and Technological Development Zone, Wenzhou City, Zhejiang Province

2.3.Test Facility

Site Description

Tested by : Beide (Shenzhen) Product Service Limited

Site Location : China: 6F, Bldg E, Hourui 3rd Ind Zone, Xixiang, Bao'an Dist, Shenzhen, China

2.4.Test Uncertainty

Conducted Emission Uncertainty = $\pm 2.66\text{dB}$

Radiated Emission Uncertainty = $\pm 4.26\text{dB}$

2.5. Test Condition

Test Mode: ON

2.6. Test Conditions

Temperature: 22°C-28°C

Relative Humidity: 45%-68%

2.7. Performance Criterion

Performance criterion **A**:

The equipment shall continue to operate as intended during the test.

No change of actual operating state (for example change of channel) is allowed as a result of the application of the test.

Multifunction equipment shall for each function meet the relevant requirements.

Evaluation is carried out for audio and video functions.

Performance criterion **B**:

The equipment shall continue to operate as intended after the test. No loss of function is allowed after the test when the apparatus is used as intended. But failures which are recovered automatically but which cause temporary delay in processing, are permissible. No change of actual operating state for example change of channel or stored data and settings is allowed as a result of the application of the test. During the test, degradation of performance is allowed.

3. TEST INSTRUMENT USED

3.1. For Conducted Emission Test

Item	Equipment	Manufacturer	Model No.	Serial No.	Last Cal.	Cal. Interval
1.	Spectrum Analyzer	Agilent	E4402B-ESA	US1192821	2022.05.05	1 Year
2.	EMI Test Receiver	ROHDE&SCHWARZ	ESPI	101206	2022.05.05	1 Year
3.	L.I.S.N.	SCHWARZBECK	NSLK8126	8126-224	2022.05.05	1 Year
4.	L.I.S.N.	EMCO	3825/2	11977C	2022.05.05	1 Year

3.2. For Radiation Emission Test

Item	Equipment	Manufacturer	Model No.	Serial No.	Last Cal.	Cal. Interval
1.	Spectrum Analyzer	Rohde&schwarz	FSEA20	DE25181	2022.05.05	1 Year
2.	Positioning Controller	C&C	CC-C-1F	N/A	2022.05.05	1 Year
3.	Trilog Broadband Antenna	Schwarzbeck	VULB9163	9163-333	2022.05.05	1 Year
4.	Horn Antenna	Schwarzbeck	BBHX9120	9120-426	2022.05.05	1 Year
5.	RF Switch	EM	EMSW18	SW060023	2022.05.05	1 Year
6.	Amplifier	Agilent	8447F	3113A06717	2022.05.05	1 Year
7.	Coaxial Cable	Schwarzbeck	AK9513	9513-10	2022.05.05	1 Year
8.	EMI Test Receiver	Rohde&schwarz	ESPI	25498514	2022.05.05	1 Year

3.3. For Harmonic / Flicker Test

Item	Equipment	Manufacturer	Model No.	Serial No.	Last Cal.	Cal. Interval
1.	Signal Conditioning Unit	SCHAFFNER	CCN1000-1	23980/7	2022.05.05	1 Year
2.	Signal Phase Impedance Network	SCHAFFNER	INA2152	0929-2	2022.05.05	1 Year
3.	5KVA AC Power Source	SCHAFFNER	NSG1007	2983332	2022.05.05	1 Year

3.4. For Electrostatic Discharge Immunity Test

Item	Equipment	Manufacturer	Model No.	Serial No.	Last Cal.	Cal. Interval
1.	ESD Tester	Noiseken	ESS-200AX	0223	2022.05.05	1 Year

3.5. For Radio Frequency Electromagnetic Field

Item	Equipment	Manufacturer	Model No.	Serial No.	Last Cal.	Cal. Interval
1.	Signal Generator	IFR	2032	203002/100	2022.05.05	1 Year
2.	Amplifier	A&R	150W1000	301584	2022.05.05	1 Year
3.	Dual Directional Coupler	A&R	DC6080	301508	2022.05.05	1 Year
4.	Power Head	A&R	PH2000	301193	2022.05.05	1 Year
5.	Power Meter	A&R	PM2002	302799	2022.05.05	1 Year
6.	Field Monitor	A&R	FM5004	300329	2022.05.05	1 Year
7.	Field Probe	A&R	FP5000	300221	2022.05.05	1 Year

3.6. For Electrical Fast Transient/Burst Test

Item	Equipment	Manufacturer	Model No.	Serial No.	Last Cal.	Cal. Interval
1.	Ultra Compact Simulator	EM TEST	UCS500M6	0500-19	2022.05.05	1 Year

3.7. For Surge Test

Item	Equipment	Manufacturer	Model No.	Serial No.	Last Cal.	Cal. Interval
1.	Surge Tester	HAEFELY	PSURGE4.1	080107-04	2022.05.05	1 Year

3.8. For Injected Currents Susceptibility Test

Item	Equipment	Manufacturer	Model No.	Serial No.	Last Cal.	Cal. Interval
1.	Signal Generator	IFR	2032	203002/100	2022.05.05	1 Year
2.	Amplifier	A&R	150W1000	301584	2022.05.05	NCR

3.9. For Voltage Dips and Interruptions Test

Item	Equipment	Manufacturer	Model No.	Serial No.	Last Cal.	Cal. Interval
1.	Dips Tester	HEAFELY	PLINE 1610	083732-18	2022.05.05	1 Year

4. POWER LINE CONDUCTED EMISSION TEST

4.1. Block Diagram of Test Setup

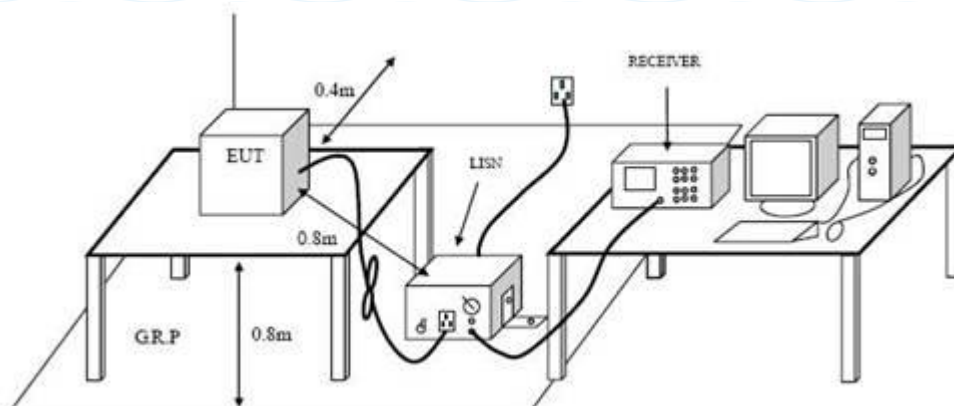

4.2. Test Standard

EN 61000-6-3:2007+A1:2011

4.3. Power Line Conducted Emission Limit

Frequency MHz	Limits dB(μ V)	
	Quasi-peak Level	Average Level
0.15 ~ 0.50	66 ~ 56*	56 ~ 46*
0.50 ~ 5.00	56	46
5.00 ~ 30.00	60	50

Notes: 1. *Decreasing linearly with logarithm of frequency.
2. The lower limit shall apply at the transition frequencies.

4.4. EUT Configuration on Test

The following equipments are installed on conducted emission test to meet the test requirement and operating in a manner, which tends to maximize its emission characteristics in a normal application.

- 4.4.1. SOCKET
 Model Number : MT2001
 Manufacturer : Wenzhou Yijie Electric Co., Ltd

4.5. Operating Condition of EUT

4.5.1. Setup the EUT and simulators as shown in Section 4.1.

4.5.2. Turn on the power of all equipments.

4.5.3. Let the EUT work in test mode (ON) and test it.

4.6. Test Procedure

The EUT is put on the ground and connected to the AC mains through an Artificial Mains Network (L.I.S.N.). This provided 50ohm-coupling impedance for the tested equipments. Both sides of AC line are checked to find out the maximum conducted emission levels according to the EN 61000-6-3 regulations during conducted emission test.

The bandwidth of the test receiver (R&S Test Receiver ESPI) is set at 10kHz.

The frequency range from 150 kHz to 30 MHz is investigated. The scanning waveform are attached within Appendix I.

4.7. Power Line Conducted Emission Test Results

N/A

5. RADIATION EMISSION TEST

5.1. Block Diagram of Test Setup

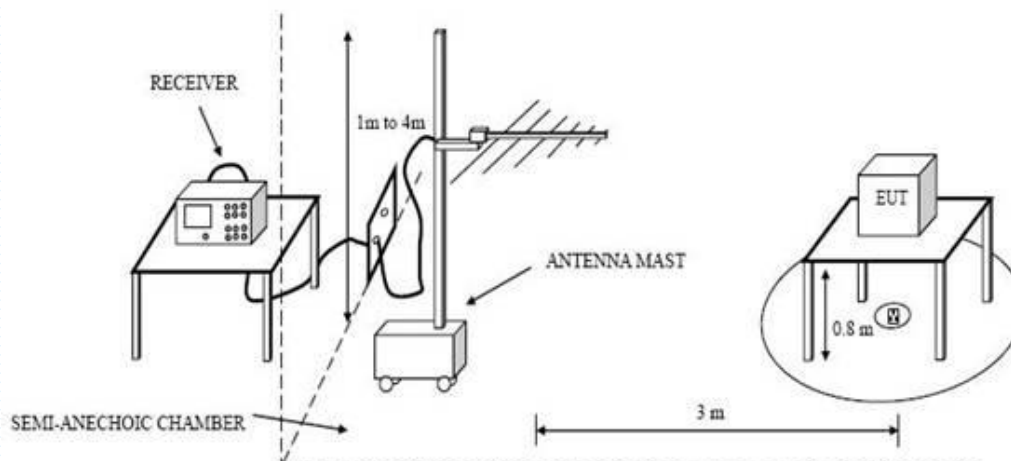

5.2. Test Standard

EN 61000-6-3:2007+A1:2011

5.3. Radiation Emission Limit

All emanations from a Class B computing devices or system, including any network of conductors and apparatus connected thereto, shall not exceed the level of field strengths specified below:

FREQUENCY (MHz)	DISTANCE (Meters)	FIELD STRENGTHS LIMITS (dB μ V/m)
30 ~ 230	3	40
230 ~ 1000	3	47

Notes: 1. The tighter limit shall apply at the edge between two frequency bands.
2. Distance refers to the distance in meters between the measuring instrument antenna and the closed point of any part of the EUT.

5.4. EUT Configuration on Test

The test Class B regulations test method must be used to find the maximum emission during radiated emission test.

The configuration of EUT is same as used in the test.

5.5.Operating Condition of EUT

- 5.5.1. Setup the EUT as shown on Section 5.1.
- 5.5.2. Turn on the power of all equipments.
- 5.5.3. Let the EUT work in test mode (ON) and measure it and test it.

5.6.Test Procedure

The EUT is placed on a turn table which is 0.8 meter above ground. The turn table can rotate 360 degrees to determine the position of the maximum emission level. The EUT is set 3 meters away from the receiving antenna which is mounted on a antenna tower. The antenna can move up and down between 1 to 4 meters to find out the maximum emission level. Broadband antenna(calibrated by dipole antenna) are used as a receiving antenna. Both horizontal and vertical polarization of the antenna is set on test.

The bandwidth setting on the test receiver(R&S TEST RECEIVER ESPI) is 120kHz. The EUT is tested in Anechoic Chamber.

5.7.Radiation Emission Test Results

N/A

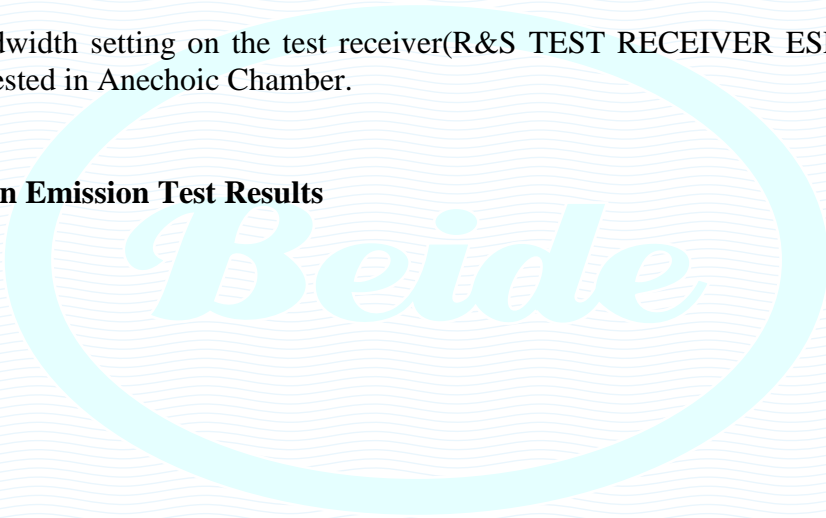

6.HARMONIC CURRENT EMISSION TEST

6.1.Block Diagram of Test Setup

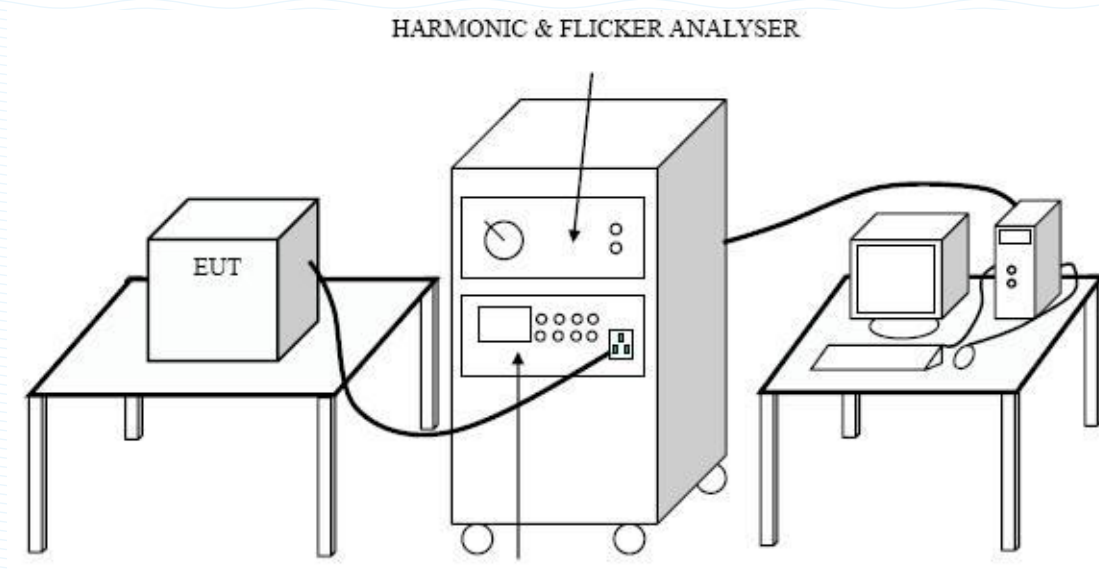

6.2.Test Standard

EN IEC 61000-3-2:2019+A1:2021, Class-A

6.3.Operating Condition of EUT

Same as Section 4.5 except the test set up replaced by Section 6.1.

6.4.Test Results

N/A

7.VOLTAGE FLUCTUATIONS & FLICKER TEST

7.1.Block Diagram of Test Setup

Same as Section 6.1.

7.2.Test Standard

EN 61000-3-3:2013+A1:2019

7.3.Operating Condition of EUT

Same as Section 4.5 except the test set up replaced by Section 7.1.

7.4.Test Results

N/A



8.ELECTROSTATIC DISCHARGE TEST

8.1.Block Diagram of Test Setup

8.1.1. Block Diagram of ESD Test Setup (Direct Discharge)

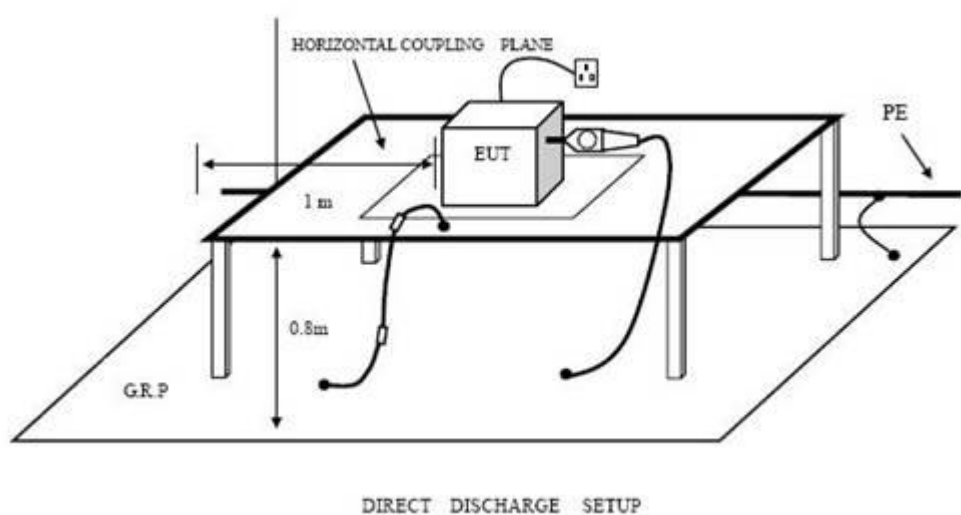

8.1.2. Block Diagram of ESD Test Setup (Indirect Discharge)

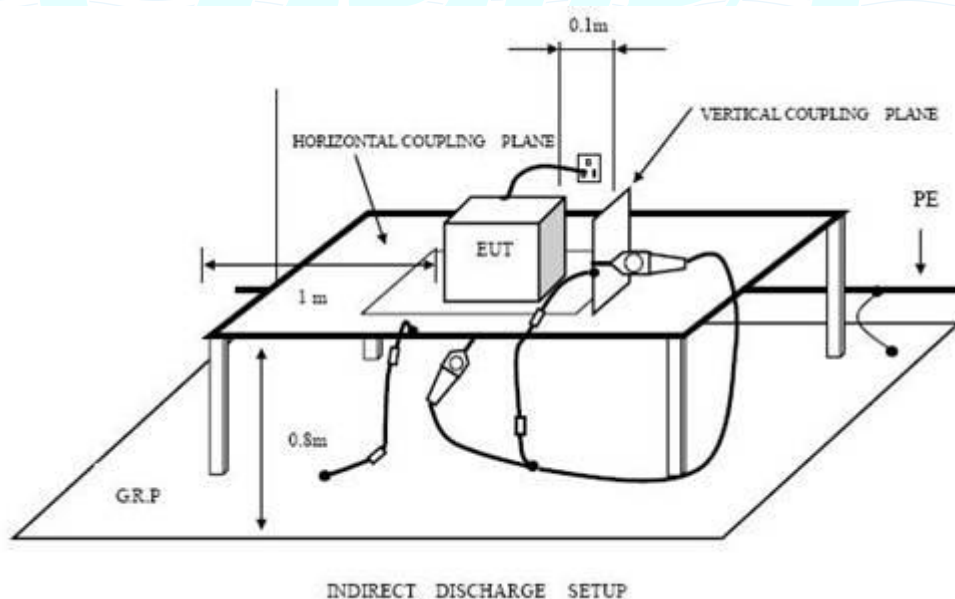

8.2.Test Standard

EN IEC 61000-6-1:2019 (EN 61000-4-2:2009)
Severity Level 3 for Air Discharge at 8kV
Severity Level 2 for Contact Discharge at 4kV

8.3. Severity level and Performance criterion

Severity level

Level	Test Voltage Contact Discharge (kV)	Test Voltage Air Discharge (kV)
1.	2	2
2.	4	4
3.	6	8
4.	8	15
X.	Special	Special

Performance criterion: **B**

8.4. EUT Configuration on Test

The configuration of EUT is listed in Section 4.4.

8.5. Operating Condition of EUT

8.5.1. Setup the EUT as shown in Section 4.5. except the test set up replaced by section 8.1.

8.6. Test Procedure

8.6.1. Air Discharge:

This test is done on non-conductive surfaces. The round discharge tip of the discharge electrode shall be approached as fast as possible to touch the EUT.

After each discharge, the discharge electrode shall be removed from the EUT.

The generator is then re-triggered for a new single discharge and repeated 10 times for each pre-selected test point. This procedure shall be repeated until all the air discharge completed.

8.6.2. Contact Discharge:

All the procedure shall be same as Section 8.6.1 except that the tip of the discharge electrode shall touch the EUT before the discharge switch is operated.

8.7. Test Results

PASS

Please refer to the following page.

Electrostatic Discharge Test Results

Beide (Shenzhen) Product Service Limited

Date: 2022-06-06

Applicant	: Wenzhou Yijie Electric Co., Ltd	Test Date	: 2022-06-06
EUT	: SOCKET	Temperature	: 24°C
M/N	: MT2001	Humidity	: 49%
Power Supply	: AC230V,50Hz	Test Mode	: ON
Test Engineer	: Jack		

Air Discharge: $\pm 8\text{kV}$ For each point positive 10 times and negative 10 times

Contact Discharge: $\pm 4\text{kV}$ For each point positive 25 times and negative 25 times

Location		Kind	Result
		A-Air Discharge C-Contact Discharge	
Slots	20 points	A	PASS
Surface	10 points	A	PASS
Screw	10 points	A	PASS
HCP	5 points	C	PASS
VCP	5 points	C	PASS

Discharge should be considered on Contact and Air and Horizontal Coupling Plane (HCP) and Vertical Coupling Plane (VCP).

Reviewer: Austin Zhang

9. RF FIELD STRENGTH SUSCEPTIBILITY TEST

9.1. Block Diagram of Test Setup

9.1.1. Block diagram of Test Setup

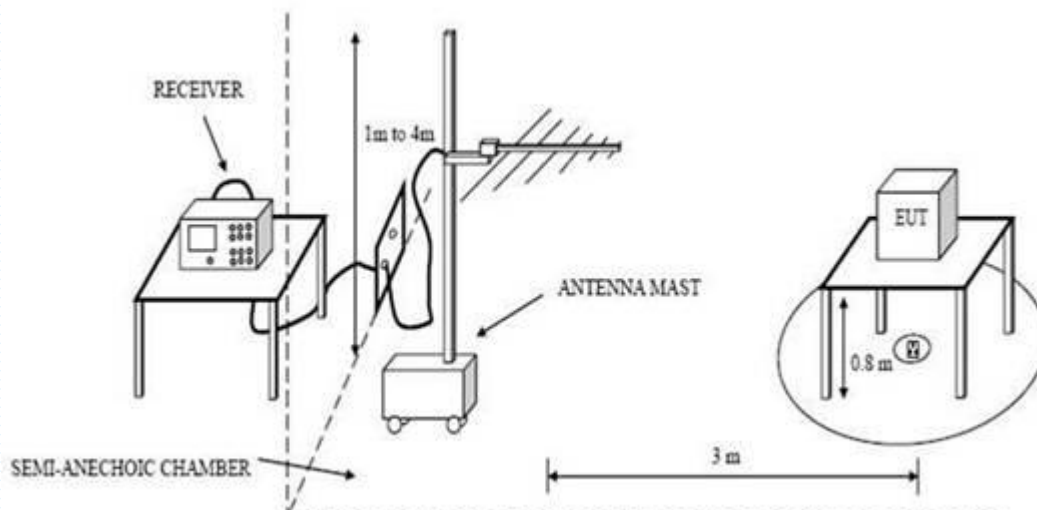

9.2. Test Standard

EN IEC 61000-6-1:2019 (EN 61000-4-3:2006+A2:2010)
Severity Level 2 at 3V/m

9.3. Severity level and Performance criterion

9.3.1. Severity level

Level	Field Strength V/m
1.	1
2.	3
3.	10
X.	Special

Performance criterion : A

9.4. EUT Configuration on Test

The configuration of EUT is listed in Section 4.4.

9.5. Operating Condition of EUT

Setup the EUT as shown in Section 9.1. The operating condition of EUT is listed in section 4.5.

9.6. Test Procedure

The EUT and its simulators are placed on a turn table which is 0.8 meter above the ground. The EUT is set 3 meters away from the transmitting antenna which is mounted on an antenna tower. Both horizontal and vertical polarization of the antenna are set on test. Each of the four sides of EUT must be faced this transmitting antenna and measured individually. In order to judge the EUT performance, a CCD camera is used to monitor the EUT. All the scanning conditions are as follows:

Condition of Test	Remarks
Fielded Strength	3 V/m (Severity Level 2)
Radiated Signal	Modulated
Scanning Frequency	80 MHz-6.0 GHz
Sweeping time of radiated	0.0015 decade/s
Dwell Time	1 Sec.

9.7. Test Results

N/A

Please refer to the following page.

RF Field Strength Susceptibility Test Results

Beide (Shenzhen) Product Service Limited

Date: 2022-06-06

Applicant	: Wenzhou Yijie Electric Co., Ltd	Test Date	: 2022-06-06
EUT	: SOCKET	Temperature	: 24°C
M/N	: MT2001	Humidity	: 49%
Power Supply	: AC230V,50Hz	Test Mode	: ON
Test Engineer	: Jack	Frequency Range	: 80 MHz-6.0 GHz
Modulation:	<input checked="" type="checkbox"/> AM	<input type="checkbox"/> Pulse	<input type="checkbox"/> none 1 kHz 80%
Criterion : A			
	Frequency Range: 80 MHz-6.0 GHz		
Steps	1%	1%	
	Horizontal	Vertical	
Front	N/A	N/A	
Right	N/A	N/A	
Rear	N/A	N/A	
Left	N/A	N/A	

Reviewer :

Austin Zhang

10. ELECTRICAL FAST TRANSIENT/BURST TEST

10.1. Block Diagram of Test Setup

10.1.1. Block diagram of Test Setup

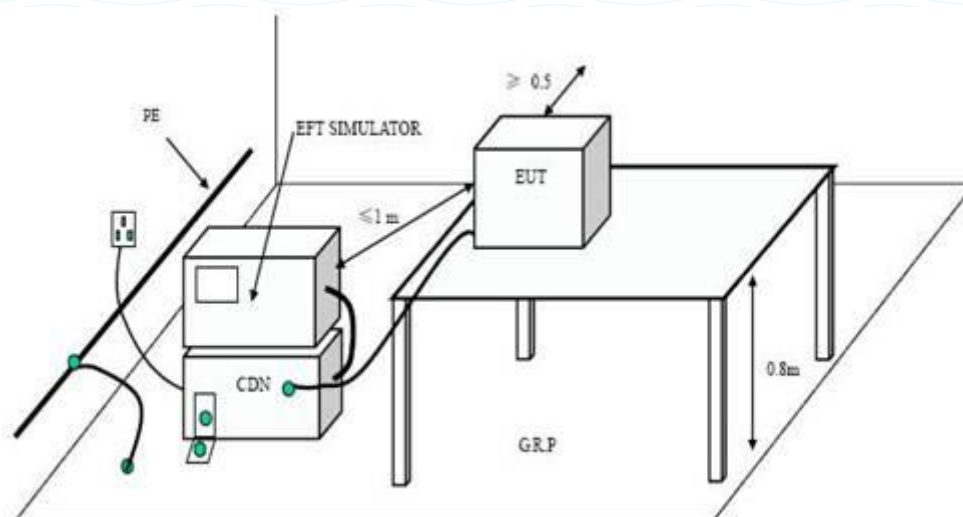

10.2. Test Standard

EN IEC 61000-6-1:2019 (EN 61000-4-4:2012)
Severity Level 2 at 1kV

10.3. Severity level and Performance criterion

10.3.1. Severity level

Level	Open Circuit Output Test Voltage $\pm 10\%$	
	On Power Supply Lines	On I/O (Input/Output) Signal data and control lines
1.	0.5 kV	0.25 kV
2.	1 kV	0.5 kV
3.	2 kV	1 kV
4.	4 kV	2 kV
X	Special	Special

Performance criterion : **B**

10.4. EUT Configuration on Test

The configuration of EUT is listed in Section 4.4.

10.5. Operating Condition of EUT

Setup the EUT as shown in Section 10.1. The operating condition of EUT is listed in section 4.5.

10.6. Test Procedure

The EUT is put on the table which is 0.8 meter high above the ground reference plane which is a min 1m*1m metallic sheet with 0.65mm minimum thickness. This reference ground plane shall project beyond the EUT by at least 0.8m on all sides and the minimum distance between the EUT and all other conductive structure, except the ground plane beneath the EUT, shall be more than 0.5m.

10.6.1. For input and output AC power ports:

The EUT is connected to the power mains by using a coupling device which couples the EFT interference signal to AC power lines. Both polarities of the test voltage should be applied during compliance test and the duration of the test is 2 mins.

10.6.2. For signal lines and control lines ports:

It's unnecessary to test.

10.6.3. For DC output line ports:

It's unnecessary to test.

10.7. Test Results

N/A

Please refer to the following page.

Electrical Fast Transient/Burst Test Results

Beide (Shenzhen) Product Service Limited

Date: 2022-06-06

Applicant	: Wenzhou Yijie Electric Co., Ltd	Test Date	: 2022-06-06
EUT	: SOCKET	Temperature	: 24°C
M/N	: MT2001	Humidity	: 49%
Power Supply	: AC230V,50Hz	Test Mode	: ON
Test Engineer	: Jack		

Inject Place : AC Mains									
Inject Line	Voltage kV	Inject Time(s)	Inject Method	Results	Inject Line	Voltage kV	Inject Time(s)	Inject Method	Results
L	±1	120	Direct	N/A					
N	±1	120	Direct	N/A					
PE	±1	120	Direct	N/A					
L+N+PE	±1	120	Direct	N/A					

Reviewer: Austin Zhang

11. SURGE TEST

11.1. Block Diagram of Test Setup

11.1.1. Block diagram of Test Setup

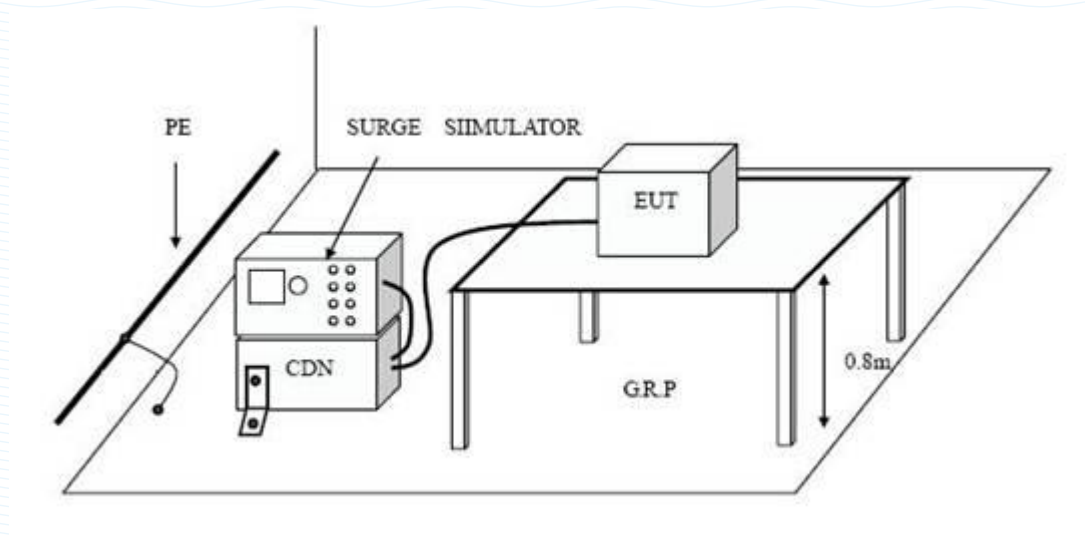

11.2. Test Standard

EN IEC 61000-6-1:2019 (EN 61000-4-5:2014+A1:2017)

Severity Level 2 at 1kV for line-line, Severity Level 3 at 2 kV for line-earth

11.3. Severity level and Performance criterion

11.3.1. Severity level

Severity Level	Open-Circuit Test Voltage kV
1	0.5
2	1.0
3	2.0
4	4.0
*	Special

Performance criterion: **B**

11.4. EUT Configuration on Test

The configuration of EUT is listed in Section 4.4.

11.5. Operating Condition of EUT

Setup the EUT as shown in Section 11.1. The operating condition of EUT is listed in section 4.5.

11.6. Test Procedure

- 1) Set up the EUT and test generator as shown on section 11.1.
- 2) For line to line coupling mode, provide a 1kV 1.2/50us voltage surge (at open-circuit condition) and 8/20us current surge to EUT selected points.
- 3) At least 5 positive and 5 negative (polarity) tests with a maximum 1/min repetition rate are conducted during test.
- 4) Different phase angles are done individually.
- 5) Repeat procedure 2) to 4) except the open-circuit test voltage change from 1kV to 2kV for line to earth coupling mode test.
- 6) Record the EUT operating situation during compliance test and decide the EUT immunity criterion for above each test.

11.7. Test Results

N/A

Please refer to the following page.



Beide

Surge Immunity Test Results

Beide (Shenzhen) Product Service Limited.

Date: 2022-06-06

Applicant : <u>Wenzhou Yijie Electric Co., Ltd</u>				Test Date : <u>2022-06-06</u>	
EUT : <u>SOCKET</u>				Temperature : <u>24°C</u>	
M/N : <u>MT2001</u>				Humidity : <u>49%</u>	
Power Supply : <u>AC230V,50Hz</u>				Test Mode : <u>ON</u>	
Location	Polarity	Phase Angle	No of Pulse	Pulse Voltage (kV) EN 61000-4-5	Result
L-N	±	0	5	1	N/A
	±	90	5	1	N/A
	±	180	5	1	N/A
	±	270	5	1	N/A
L-PE, N-PE	±	0	5	2	N/A
	±	90	5	2	N/A
	±	180	5	2	N/A
	±	270	5	2	N/A
Remark:					

Reviewer: _____

Austin Zhang

12. INJECTED CURRENTS SUSCEPTIBILITY TEST

12.1. Block Diagram of Test Setup

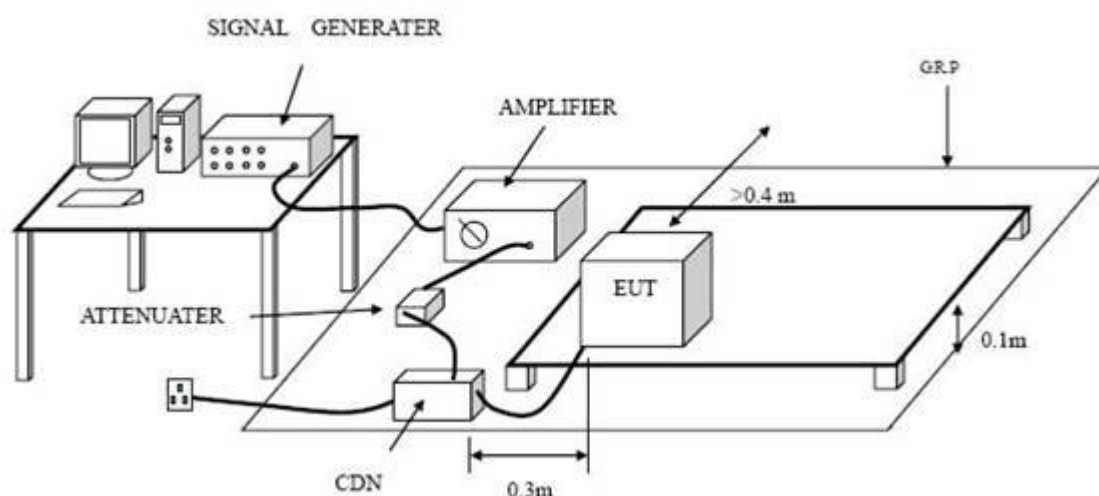

12.2. Test Standard

EN IEC 61000-6-1:2019 (EN 61000-4-6:2014+AC:2015)
Severity Level 2 at 3V (rms), 0.15MHz ~ 80MHz

12.3. Severity Levels and Performance Criterion

12.3.1 Severity level

Level	Field Strength V/m
1.	1
2.	3
3.	10
X	Special

Performance criterion: A

12.4. EUT Configuration on Test

The configuration of EUT is listed in Section 4.4.

12.5. Operating Condition of EUT

12.5.1 Setup the EUT as shown in Section 12.1.

12.5.2 Turn on the power of all equipments.

12.6. Test Procedure

- 1) Set up the EUT, CDN and test generators as shown on Section 12.1.
- 2) Let the EUT work in test mode and test it.
- 3) The EUT are placed on an insulating support 0.8m high above a ground reference plane. CDN(coupling and decoupling device) is placed on the ground plane about 0.3m from EUT. Cables between CDN and EUT are as short as possible, and their height above the ground reference plane shall be between 30 and 50 mm (where possible).
- 4) The disturbance signal described below is injected to EUT through CDN.
- 5) The EUT operates within its operational mode(s) under intended climatic conditions after power on.
- 6) The frequency range is swept from 150 kHz to 80MHz using 3V signal level, and with the disturbance signal 80% amplitude modulated with a 1 kHz sine wave.
- 7) The rate of sweep shall not exceed 1.5×10^{-3} decades/s. Where the frequency is swept incrementally, the step size shall not exceed 1% of the start and thereafter 1% of the preceding frequency value.
- 8) Recording the EUT operating situation during compliance testing and decide the EUT immunity criterion.

12.7. Test Results

N/A

Please refer to the following page.

Injected Currents Susceptibility Test Results

Beide (Shenzhen) Product Service Limited

Date: 2022-06-06

Applicant : <u>Wenzhou Yijie Electric Co., Ltd</u>			Test Date : <u>2022-06-06</u>	
EUT : <u>SOCKET</u>			Temperature : <u>24°C</u>	
M/N : <u>MT2001</u>			Humidity : <u>49%</u>	
Power Supply : <u>AC230V,50Hz</u>			Test Mode : <u>ON</u>	
Test Engineer : <u>Jack</u>				
Frequency Range (MHz)	Injected Position	Strength	Criterion	Result
0.15 ~ 80	AC Mains	3V(rms), Unmodulated	A	N/A
Remark : 1. Modulation Signal:1kHz 80% AM			Note:	

Reviewer: Austin Zhong

13. VOLTAGE DIPS AND INTERRUPTIONS TEST

13.1. Block Diagram of Test Setup

13.1.1. Block diagram of Test Setup

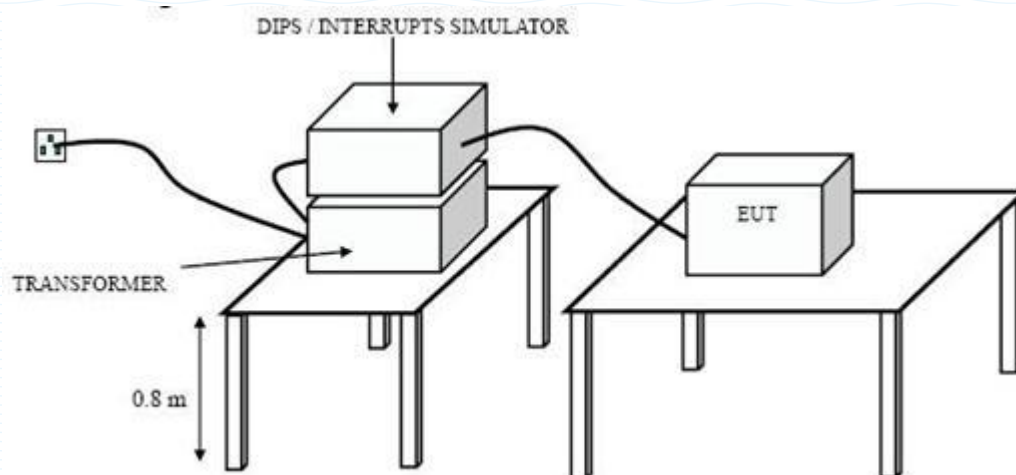

13.2. Test Standard

EN IEC 61000-6-1:2019 (EN 61000-4-11:2004+A1:2017)

13.3. Severity level and Performance criterion

13.3.1. Severity level

Voltage dip and short interruptions $\%U_T$	Duration (in period)
0	0P
0	1P
70	25/30P
0	250/300P

Performance criterion : B&C

13.4. EUT Configuration

The configuration of EUT is listed in section 4.4

13.5. Operating Condition of EUT

- 13.5.1. Setup the EUT as shown on Section 13.1.
- 13.5.2. Turn on the power of all equipments.
- 13.5.3. Let the EUT work in test mode (ON) and measure it and test it.

13.6. Test Procedure

- 1) Set up the EUT and test generator as shown on section 13.1.
- 2) The interruption is introduced at selected phase angles with specified duration. There is a 3mins minimum interval between each test event.
- 3) After each test a full functional check is performed before the next test.
- 4) Repeat procedures 2 & 3 for voltage dips, only the test level and duration is changed. Record any degradation of performance.

13.7. Test Results

N/A

Please refer to the following page.

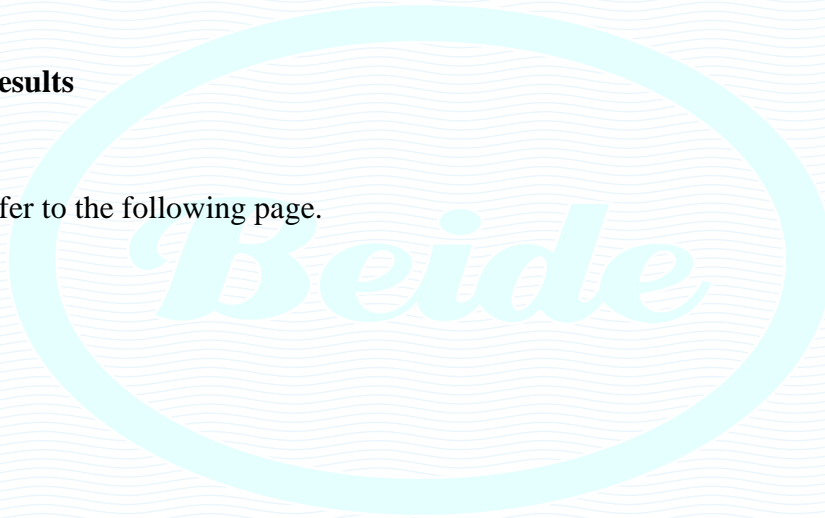

Voltage Dips And Interruptions Test Results

Beide (Shenzhen) Product Service Limited

Date: 2022-06-06

Applicant : <u>Wenzhou Yijie Electric Co., Ltd</u>		Test Date : <u>2022-06-06</u>		
EUT : <u>SOCKET</u>		Temperature : <u>24°C</u>		
M/N : <u>MT2001</u>		Humidity : <u>49%</u>		
Power Supply : <u>AC230V,50Hz</u>				
<input checked="" type="checkbox"/> Single Test Voltage		<input type="checkbox"/> Dual Test Voltage		
Test Mode: ON				
Voltage Dips & Short Interruptions % U_T	Duration (in period)	Phase Angle	Criterion	Result
0	0P	0-360	B	N/A
0	1P	0-360	B	N/A
70	25P	0-360	C	N/A
0	250P	0-360	C	N/A
Remark: U_T is the rated voltage for the equipment.				

Reviewer: Austin Zhong

APPENDIX I
(EUT Photos)

Beide

Figure 1
APPEARANCE OF EUT
Model MT2001

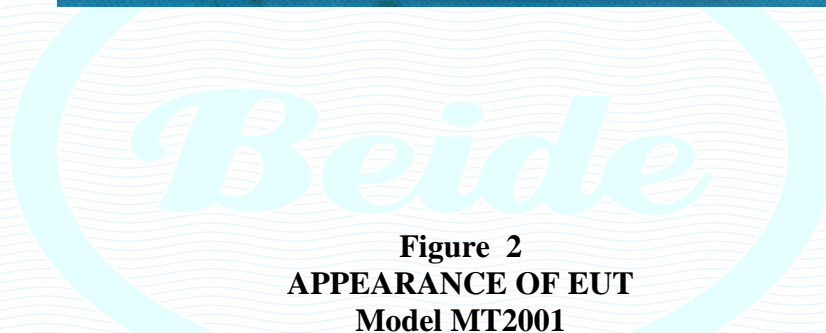
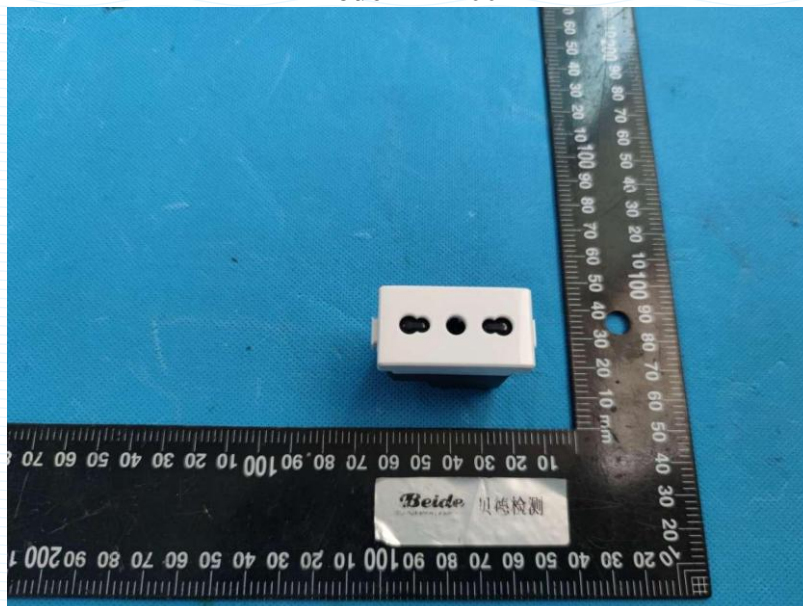

Figure 2
APPEARANCE OF EUT
Model MT2001



Figure 3
APPEARANCE OF EUT
Model MT2001

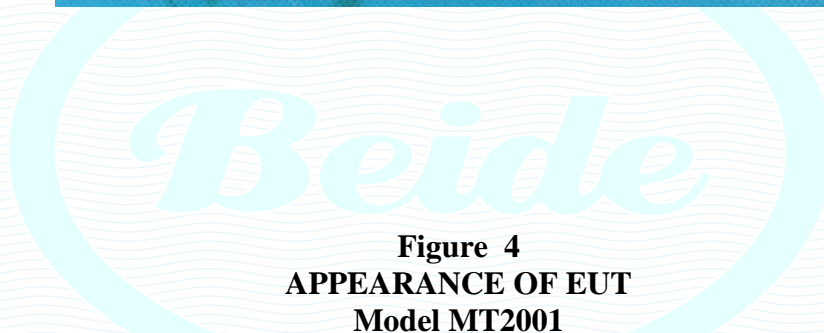

Figure 4
APPEARANCE OF EUT
Model MT2001



Figure 5
APPEARANCE OF EUT
Model MT2001

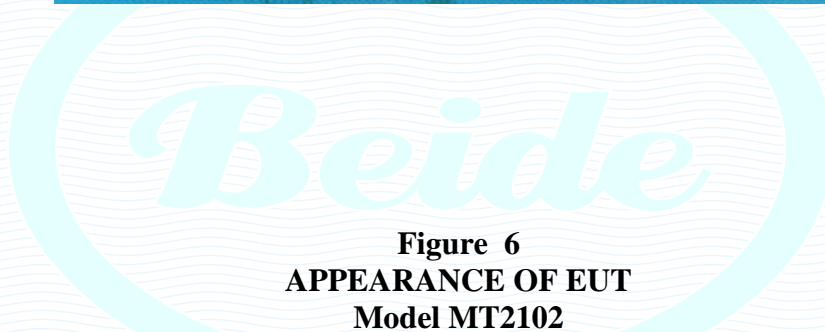

Figure 6
APPEARANCE OF EUT
Model MT2102



Figure 7
APPEARANCE OF EUT
Model MT2102

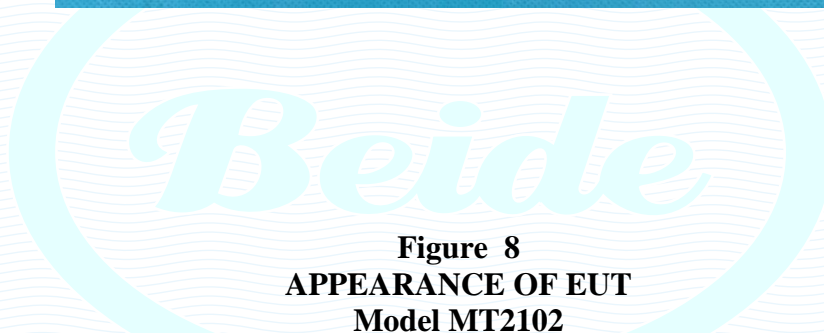
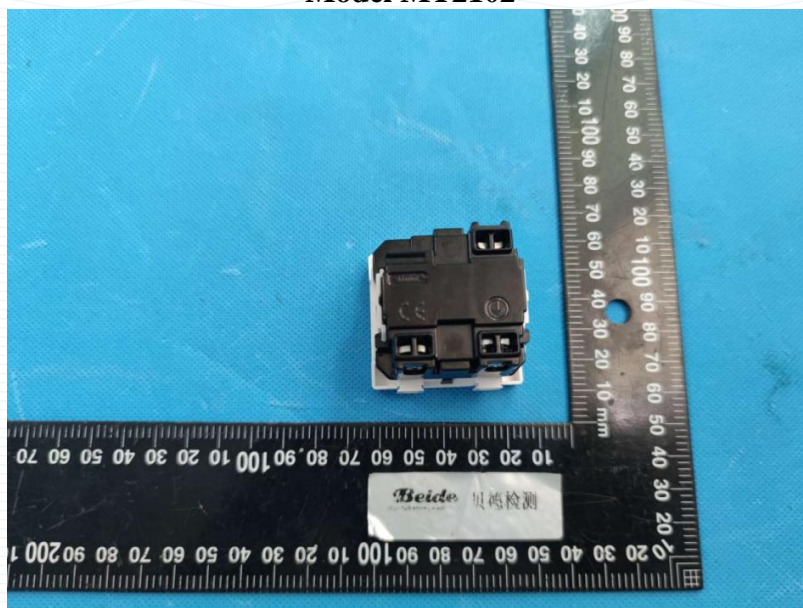

Figure 8
APPEARANCE OF EUT
Model MT2102



Figure 9
APPEARANCE OF EUT
Model MT2102

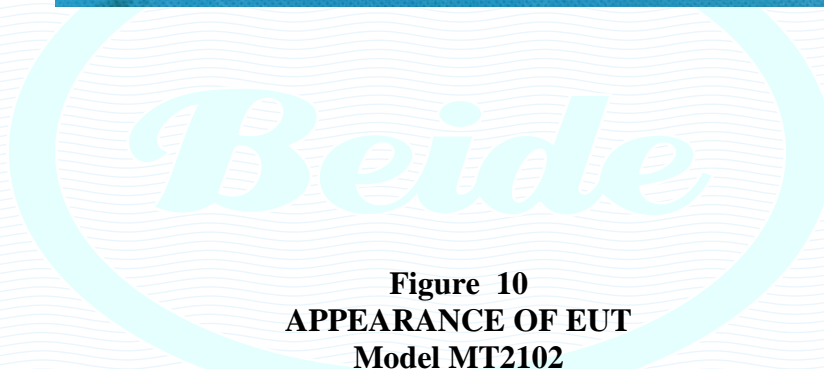

Figure 10
APPEARANCE OF EUT
Model MT2102

